

**M12 MALE 0° / MSUD VALVE PLUG FORM A 18MM**

PUR 3X0.75 black UL/CSA, drag ch 5m

Form A (18 mm) – M12, male straight

24 V AC  $\pm 20\%$  / DC  $\pm 25\%$ 

LED and suppression

Bridged PE

A-coded

Further cable lengths on request.

Plastic housings with good resistance against chemicals and oils.

The resistance to aggressive media should be individually tested for your application. Further details on request.

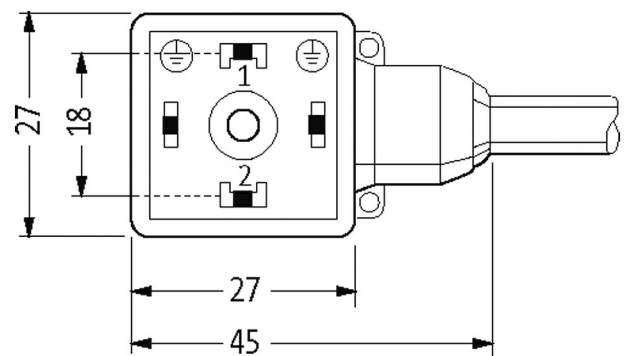
**Illustration**

Height: 30 mm



Female

Male

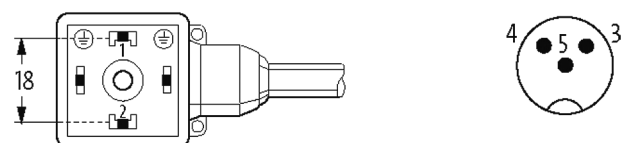

Product may differ from Image

**Approvals**

cCSAus

\* only for products with UL/CSA approved cable

**Form**

Form 40881

**Cables**

No./diameter of wires	3 × 0.75 mm <sup>2</sup>
Wire isolation	PP (bk num, gnye)
C-track properties	10 Mio.
Material (jacket)	PUR (UL/CSA)
Outer Ø	5.9 mm ±5%
Bend radius (moving)	10 × outer Ø
Temperature range (fixed)	-40...+80 °C
Temperature range (mobile)	-25...+80 °C
Cable identification	636
Cable Type	3 (PUR)
Approval (cable)	cURus (AWM-Style 20549/10493); CE conform
Cable weight [g/m]	56,10
Material (wire)	Cu wire, bare
Resistor (core)	max. 26 Ω/km (20 °C)
Single wire Ø (core)	0.15 mm
Construction (core)	42 × 0.15 mm (multi-strand wire class 6)
Diameter (core)	3 × 0.75 mm <sup>2</sup>
AWG	similar to AWG 18
Material (wire isolation)	PP
Material property (wire isolation)	CFC-, halogen-, cadmium-, silicone- and lead-free
Shore hardness (wire isolation)	70 ±5 D
Wire-Ø incl. isolation	1.85 mm ±5%
Color/numbering of wires	bk numbered, gnye longitudinally striped
Stranding combination	3 wires twisted
Shield	no
Material (jacket)	PUR
Material property (jacket)	CFC-, halogen-, cadmium-, silicone- and lead-free, matt, low-adhesion, machine easy to process, abrasion-resistant, hydrolysis and microbial resistant
Shore hardness (jacket)	90 ±5 A
Outer-Ø (jacket)	5.9 mm ±5%
Color (jacket)	black
chemical resistance	good resistance to oil, gasoline and chemicals (EN 60811-404)
thermal resistance	flame retardant UL 1581 VW1 / CSA FT1 / IEC 60332-1, IEC 60332-2-2
Nominal voltage	300 V AC
Test voltage	2500 V AC
Current load capacity	to DIN VDE 0298-4
Temperature range (fixed)	-40...+80 °C, (+90 °C at max. 10 000 operating hours)
Temperature range (mobile)	-25...+80 °C, (+90 °C at max. 10 000 operating hours)
Bend radius (fixed)	5 × outer Ø
Bend radius (moving)	10 × outer Ø
No. of bending cycles (C-track)	max. 10 Mio. (25 °C)
Travel speed (C-track)	max. 3 m/s
Acceleration (C-track)	max. 10 m/s <sup>2</sup>
Torsion stress	±180°/m
No. of torsion cycles	max. 2 Mio. (25 °C)

Torsion speed	35 cycles/min
---------------	---------------

Jacket Color	black
--------------	-------

#### Technical Data

Operating voltage	24 V AC $\pm 20\%$ / DC $\pm 25\%$
-------------------	------------------------------------

Rated surge voltage	0.8 kV
---------------------	--------

Operating current per contact	max. 4 A
-------------------------------	----------

Current consumption	max. 15 mA
---------------------	------------

Material group	IEC 60664-1, category I
----------------	-------------------------

Switch off peak	max. 55 V
-----------------	-----------

Switch off delay time	max. 20 ms
-----------------------	------------

Coding	A-coded
--------	---------

LED display	yellow
-------------	--------

Locking of ports	M3/M12 $\times$ 1 mm (recommended torque 0.4/0.6 Nm)
------------------	--

Compression gland	M12 (SW13)
-------------------	------------

Protection	IP67 inserted and tightened (EN 60529)
------------	--

Locking material	Zinc die casting, matte nickel plated
------------------	---------------------------------------

Material	MSUD (PBT); M12 (PUR)
----------	-----------------------

suitable for corrugated tube (internal $\varnothing$ )	10 mm
--	-------

Housing	Black plastic (gray on request)
---------	---------------------------------

#### General data

Pollution Degree	3
------------------	---

Temperature range	-25...+85 °C, depending on cable quality
-------------------	--

Material (gasket)	PUR
-------------------	-----

#### Commercial data

country of origin	CZ
-------------------	----

customs tariff number	85444290
-----------------------	----------

EAN	4048879151962
-----	---------------

eClass	27279218
--------	----------

Packaging unit	1
----------------	---

#### Sketch

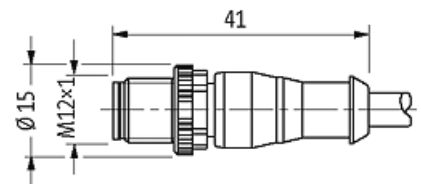

Product may differ from Image